

OPTION 1 - WALL MOUNT

OPTION 2 - FLOOR MOUNT

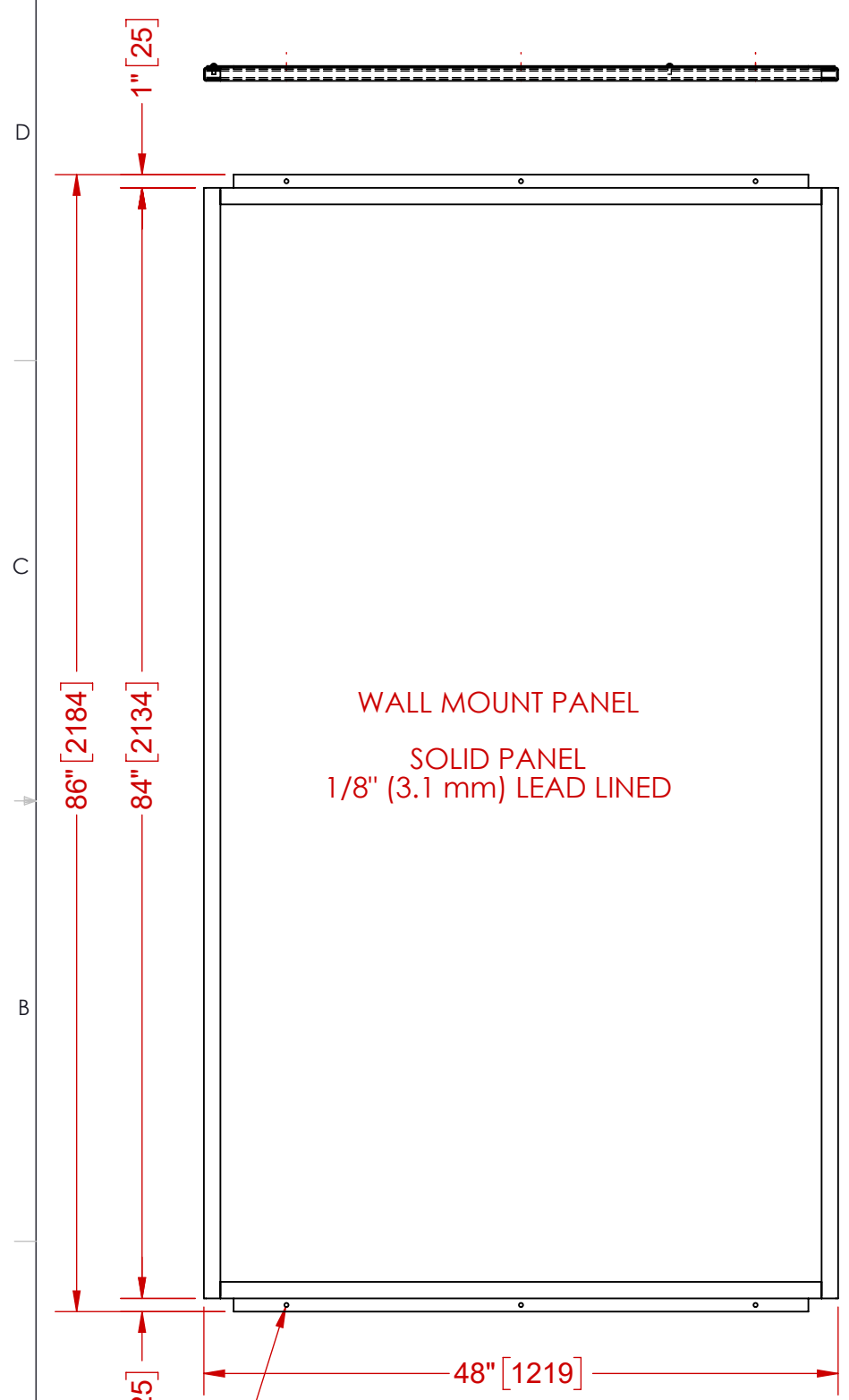

WALL MOUNT PANEL
SOLID PANEL
1/8" (3.1 mm) LEAD LINED

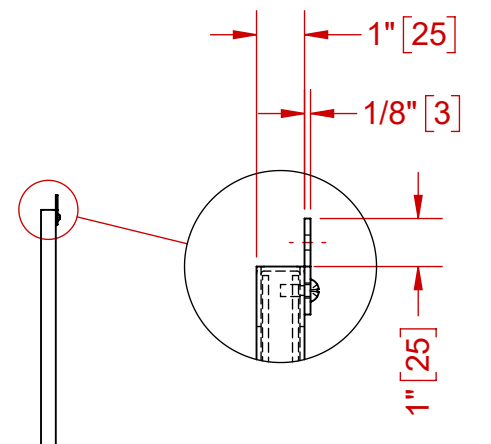

OPTION 1

CUSTOMER APPROVAL ENDORSEMENT

APPROVED AS SHOWN
 APPROVED WITH CHANGES SHOWN

BY: _____ DATE: _____

TITLE: _____

COMPANY: _____

COMMENTS: _____

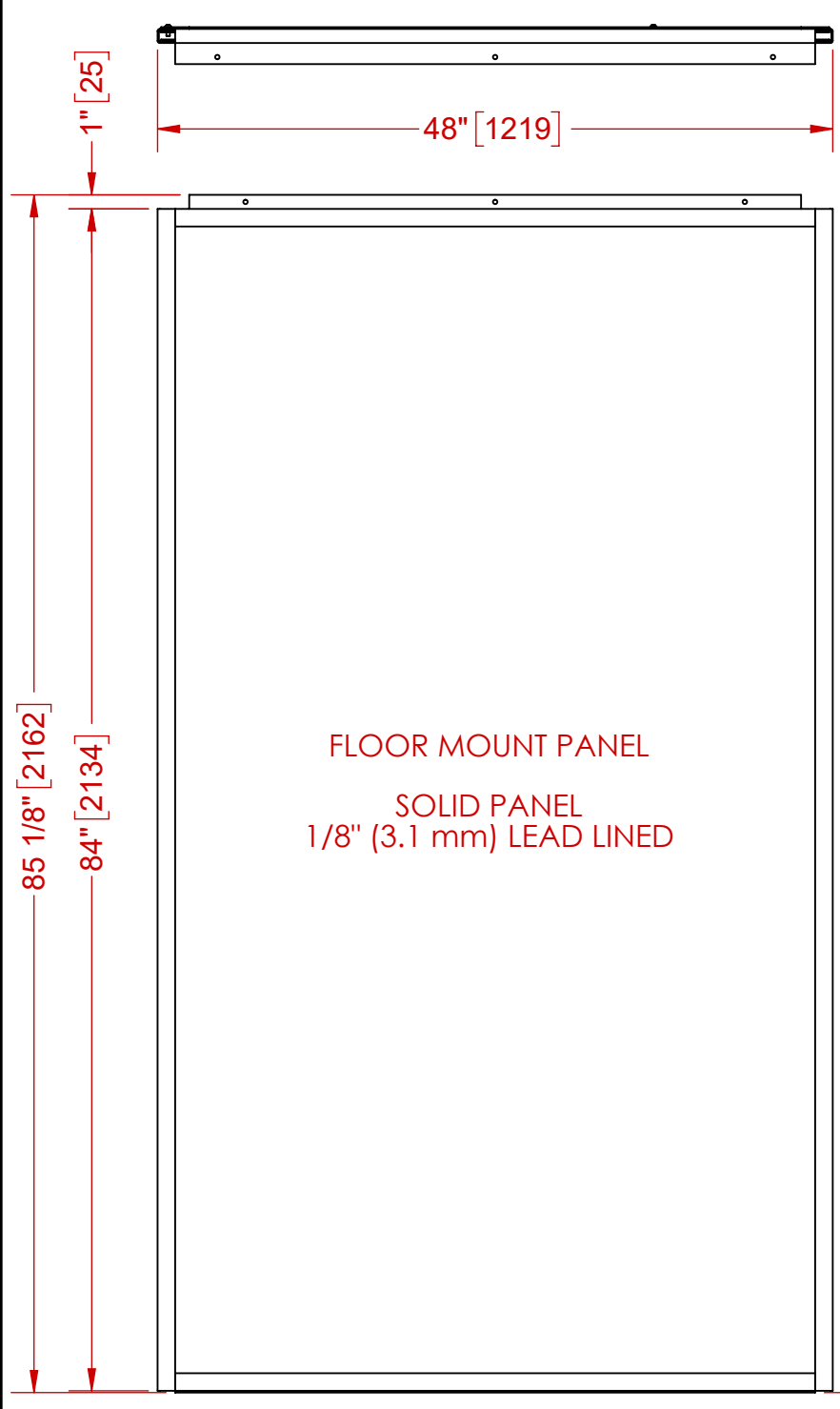
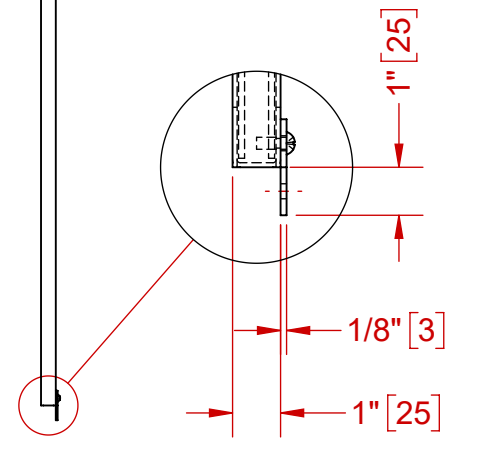

FLOOR MOUNT PANEL
SOLID PANEL
1/8" (3.1 mm) LEAD LINED

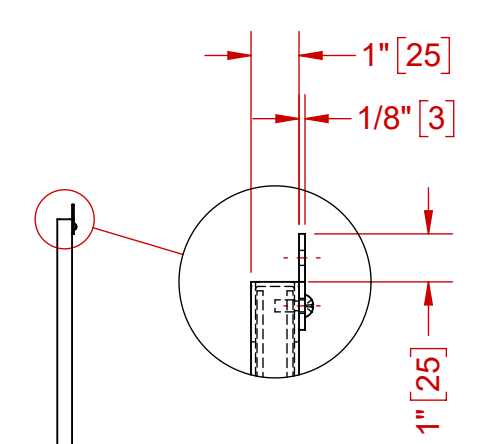

OPTION 2

CUSTOMER APPROVAL ENDORSEMENT

APPROVED AS SHOWN
 APPROVED WITH CHANGES SHOWN

BY: _____ DATE: _____

TITLE: _____

COMPANY: _____

COMMENTS: _____

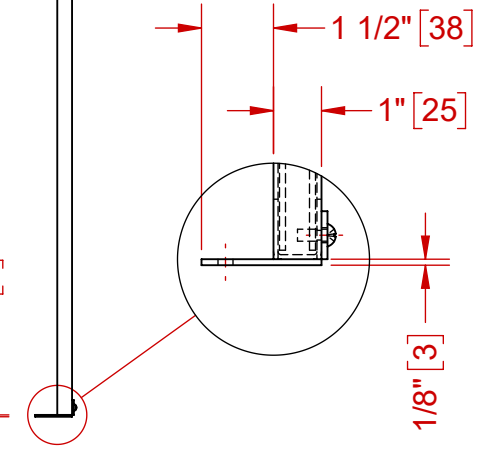

NOTES:
1) ALL UNITS ARE INCHES (mm) UNLESS OTHERWISE SPECIFIED
2) CUSTOMER TO APPROVE EITHER OPTION 1 OR OPTION 2

NOTES:

- 1) ALL UNITS ARE INCHES (mm) UNLESS OTHERWISE SPECIFIED
- 2) CUSTOMER TO APPROVE EITHER OPTION 1 OR OPTION 2

UNLESS OTHERWISE SPECIFIED		SolidWorks MAINTAINED DATA CHANGES SHALL BE INCORPORATED ELECTRONICALLY BY THE DESIGN ACTIVITY		Custom Radiation Protection, Shielding and Storage	
DO NOT SCALE DRAWING DIMENSIONS SHOWN IN PARENTHESIS ARE FOR REFERENCE ONLY (X.XX) DIMENSIONS ARE IN INCHES [mm] TOLERANCES APPLY AS SHOWN BELOW .X = ± 0.030 .XX = ± 0.010 .XXX = ± 0.005 FRACTIONS = ± 1/16 ANGLES = ± 0.5°	ALL MACHINED SURFACES TO BE 125 ALL WELD SPECIFICATIONS PER WELD SHOP	MODEL NUMBER:	TITLE	EZ PANEL	
PROPRIETARY NO PART OF THIS DOCUMENT MAY BE REPRODUCED, STORED IN A RETRIEVAL SYSTEM, OR TRANSMITTED IN ANY FORM, WITHOUT THE WRITTEN PERMISSION OF MarShield - Mars Metal Company DIVISION OF Marswell Metal Industries Ltd.		DRAWN BY M.S.D. DATE 8/16/2018	CUSTOMER/DEALER		
		CHECKED BY DATE	SIZE B DRAWING NO MSEZ4884-3.1	REVISION A	
		APPROVED DATE	SCALE 1:13	WEIGHT	SHEET 1 OF 1